



## Single Burner Gas Cooker

MODEL  
NUMBER

RG-10S  
RG-10SA

# Operating Instructions

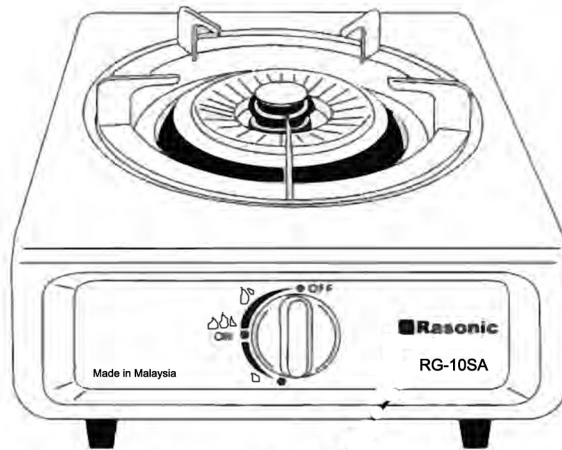

	Page
Safety Instructions .....	2 ~ 5
Before Installation .....	5
Parts Name and Operation Method .....	6
Cleaning and Maintenance .....	7
Trouble Shooting.....	8
Specifications .....	8

### Note

- Read this instruction and warranty certificate before operating the appliance, and keep it for future reference.
- To ensure the correct and safe use of this appliance, please read this Instruction carefully and follow the installation guide.
- Installation must comply with local laws and guidelines (e.g. Hong Kong Gas Safety Ordinance)
- According to the Gas Safety Ordinance of Hong Kong, any gas installation works including the installation of appliances and connection tubing, must be undertaken by registered gas installers who are registered for that appropriate classes and be employed by registered gas contractors.
- The user would be responsible for the damages and faults done by any incorrect installation to the appliance.



Warranty certificate is attached

# Safety instructions



Please comply with it

The below listed items shall be strictly followed to prevent the user and other people from suffering an injury and to prevent property from being damaged.

■ The below markings show the level of injury and damage caused when the cautions are not followed.

	<b>DANGER</b>	This marking is labelled on those items that any death or a serious injury is approaching.
	<b>WARNING</b>	This marking is labelled on those items that any death or a serious injury is approaching.
	<b>CAUTION</b>	This marking is labelled on those items that any injury and property damage is expected.

■ The below listed markings are used in the operation manual:

	This marking is given to those items to call your attention.
	This marking is give to those items banned.
	This marking is give to those items to be strictly followed



## Cautions when gas leakage is taking place

■ In case of gas leaks, close the gas main valve and ventilate the room immediately by opening windows and doors. Then, contact your gas supplier after leaving the unit.

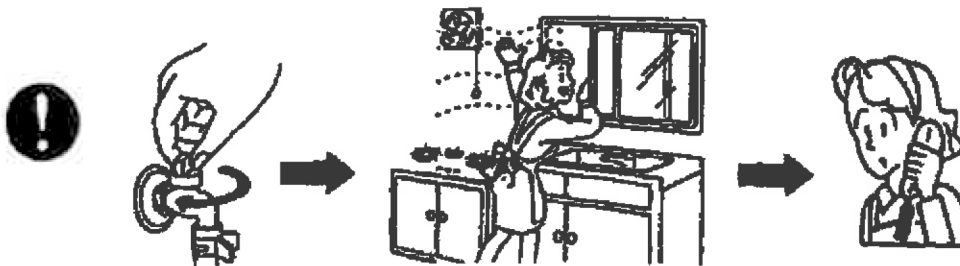

A fire or an explosion may be caused, if the above is not followed.

■ Do not turn on/off any electrical switches, electric appliances or igniting fire.

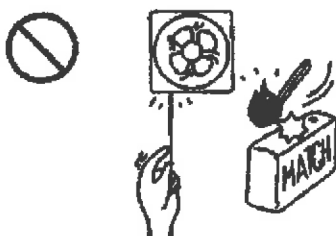

A fire or an explosion may be caused by kindling or spark.

# ⚠ WARNING

- Use only the type of gas specified on rating plate attached on the cooker.

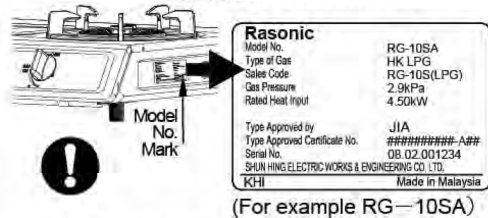

- If a different type of gas is used, a fire or a carbon monoxide toxication may be caused by an abnormal combustion.
- If the type of gas is different contact your appliance dealer.
- Do not disassemble, repair or modify the cooker.



When the cooker is in trouble, contact professional service contractor or gas appliance dealer.

- Allow minimum required space from walls and ceiling.  
If the space cannot be maintained as specified, make sure to install a heat-proof panel.

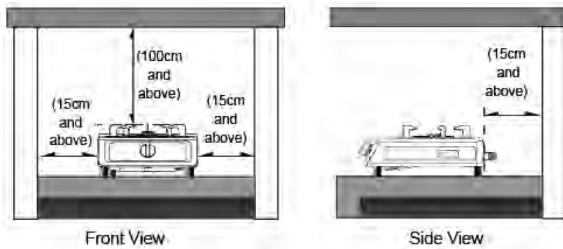

- Do not install the cooker on non-heat proof material.



A fire may be caused, if it is installed on non-heat proof material such as a carpet or a table cloth.

- Do not go to bed or go outside when the cooker is on.  
A fire or carbon monoxide toxication may be caused by lack of air supply.



- Do not use inflammables near the cooker or place inflammables on or around the cooker. A fire may be caused



- Ensure proper ventilation during operation.



If it is poorly ventilated, a carbon monoxide toxication may be caused by an incomplete combustion.

- In the abnormal condition (abnormal combustion, smell and sound, earthquake and fire) make sure to stop the operation and close the gas main valve.



If the cooker is used in such conditions, a fire or a fault may be caused.

- Do not move the cooker around during operation.



A fire or an explosion may be caused. You will get burnt.

- Make sure not to let children operate the cooker alone.



They will get burnt or be injured by improper operations.

- Please do not use aluminum foil.



May cause abnormal fire/combustion.

# Safety instructions

Please comply with it



- Do not use a divarication in the gas supply line.



A gas leak may cause a gas toxication or an explosion.

- Use suitable flexible gas tubing (Hong Kong: Tubing approved by EMSD).

- Arrange regular safety check with gas supplier and replace it before expiry date.

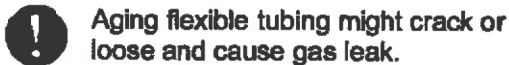

Aging flexible tubing might crack or loose and cause gas leak.

- Do not exert heat to the LPG cylinder and/or laid down the cylinder. (only applicate to LPG model)

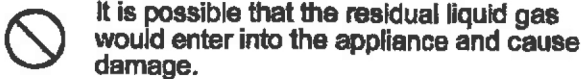

It is possible that the residual liquid gas would enter into the appliance and cause damage.

- Do not install the cooker (inside the vehicle or on the boat.



It would cause fire and unnecessary faults to the appliance while under serious vibration.

- Use cooker only for cooking



If the cooker is used for other purpose like drying clothes may be overheated or may cause an abnormal operation. Then, a fire, burning or a gas leak may be caused.

- Do not touch parts other than operational parts (ignition knob, flame control) during operation.



When the cooker is in operation, the top plate, trivets and its vicinity become extremely hot and it may cause user to get burnt.

- Fit the flexible tubing tightly over end of gas supply line and the cooker. Then secure it with a hose clip.



If the flexible tubing is not tightly secured, a gas toxication or an explosion may be caused.

- Gas hose must be bent smoothly. Do not place it under the cooker or contact with any part of the cooker.

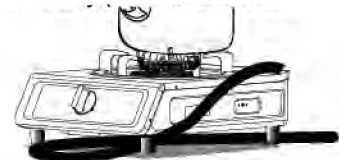

Buckling, twisting or stretching of a gas hose may cause a gas leak. Then, it may cause an explosion or a fire.

- Control the flame so that it may not come out of the bottom of a pan.



The grips of pan will be overheated by the overflowing flame. And you will get burnt or a fire may be caused.

- Do not approach to the burner when igniting the cooker.



There may be case that user will get burnt or hair will get burnt by its heat or flame.

- Risk of deflagration



If after 15 seconds the flame does not ignite, switch off the burner and open a nearby window or door. Wait at least one minute before trying to switch the burner back on.

- Please regularly check the flame.



If abnormal noise or/and unstable flame is found, please do not attempt to use. Otherwise it will result in CO poisoning.

- The burner will be turned off automatically when the flame failure sensors are activated. If the flame failure sensors is found activated, turn the ignition knob clockwise to turn off the appliance.

- Do not use an oversized cooking utensils. (diameter more than 36mm)

If oversize cooking utensils are used, carbon monoxide toxication may be caused by the abnormal combustion of the cooker.

## ⚠ CAUTION

- Make sure the burner flame is extinguished after use. Make sure the gas main valve is shut off before going out or going to bed.



If flame is not extinguished or valve is not closed properly, gas toxication or fire may be caused by a gas leakage.

- Use appropriate piping and accessories for connection.



According to the Gas Safety Ordinance of Hong Kong, any gas installation works in Hong Kong including the installation of appliances and tubing connection, must be undertaken by a registered gas installer who is registered for that appropriate classes and be employed by a registered gas contractor.

Use approved gas tubing bearing EMSD approval marking (such as : 機電工程署批准EMSD APPROVAL GTXXXX) for connection to appliances, or other appropriate methods accepted by EMSD.

## Before Installation

### Placemnet of Parts

- Properly place the small burner cap

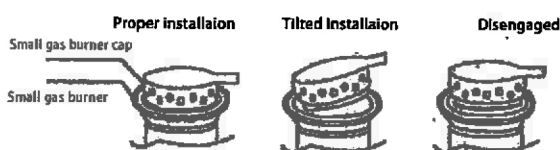

- Make sure to insert a pin of the trivet into a hole on the top plate.

If using the appliance where the trivet is tilted, the user may get burnt and cause fire.

- When placing the small burner cap, make sure the burner cap was properly placed without tilted or disengaged as shown above.

- When placing the big burner cap, press it slightly downwards such that it is completely inserted into the burner.

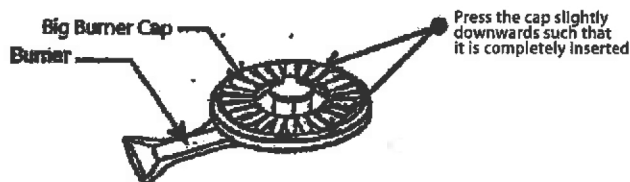

- In case the burner cap and burner is not correctly installed, the ignition will fail.

- If using the appliance where big or/and small burner cap is tilted or disengaged, it would cause the below circumstances,

- The unstable flame and back fire will cause incomplete combustion, carbon monoxide poisoning or deformation of burner cap.
- Flame retracting into burner will cause damage to the appliance.

# Before installation

## Parts Name

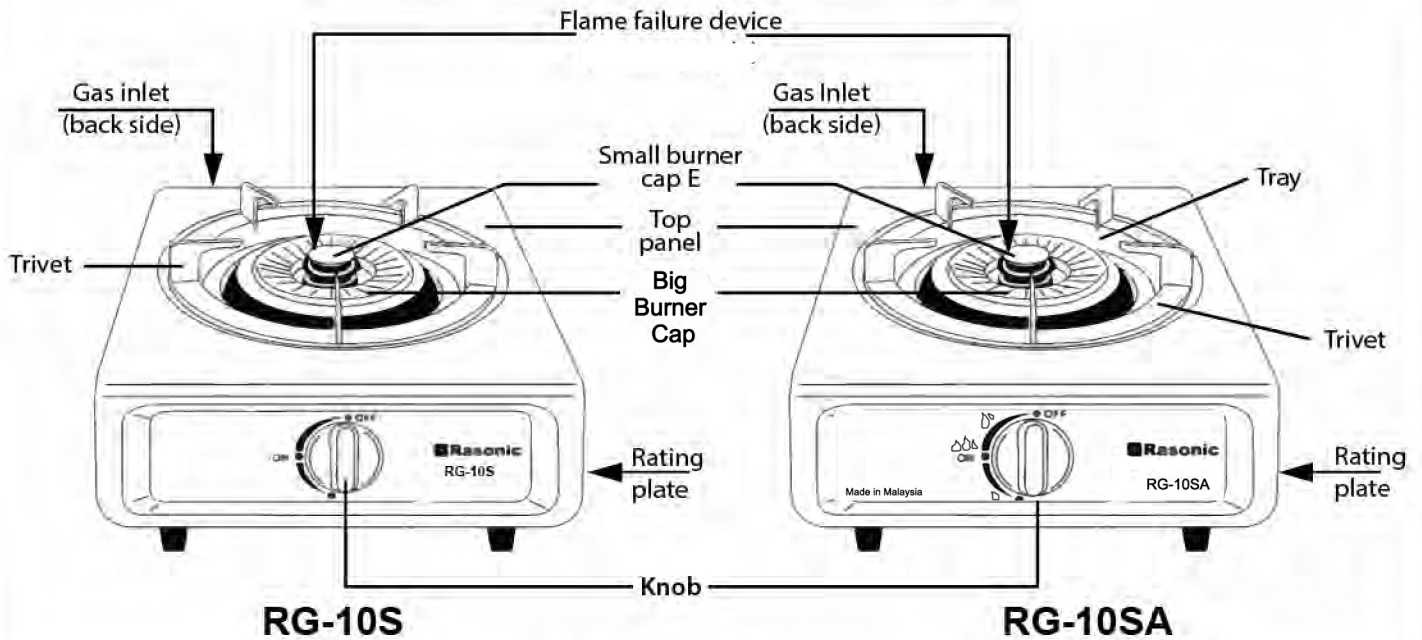

## Accessories

Part Name:	Instruction manual	Warranty card
Qty:	1 pc	1 pc

## Operating the cooker

### Turn on and confirmed ignition

- Press the ignition knob and turn it anti-clockwise to the [ON] position as shown. Then hold and wait for a five seconds. Release the knob and check the flame if ignited. If the flame can't be ignited, turn the knob to [OFF] position and repeat the above steps after 5 seconds.



### Control the flame.



### Turn off.

- Please turn the ignition knob clockwise to the [OFF] position without pressing it.



**Note:**  
Sometimes "pop" sound is heard when the burner is shut off. This is normal.

# Cleaning and Maintenance

- Do not cover the burner with a large utensil as this will result in overheat of the cooker.
- Cleaning top panel
- Apply neutral detergent on the soft cloth to clean the surface of the panel.
- Do not use alkaline detergent, petrol, other corrosive solutions or abrasive materials to clean the surface of the panel, it would permanently damage the surface finishing to the panel.

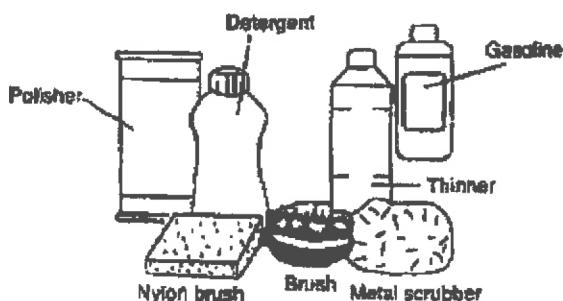

- Suggested max weight of cooking utensil (with ingredients): 10 KG
- Suggested max diameter of cooking utensil: 36cm

- Foam or soft cloth can clean the small and big burner caps. If the dirt is hard to remove, it is recommended to use soft brush.
- Do not clean it forcefully or do not bump it while brushing. After clean, make sure the cap is mounted in place.
- After washing caps, dry them.

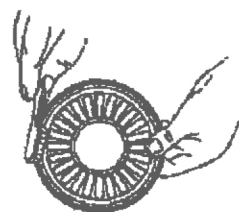

- Please use soft brush to clean the burner cap outer ring.
- Please use soft brush to clean Flame Failure Device (Thermocouple). Attention: Avoid crushing the Flame Failure Device (Thermocouple)
- Be careful from hurting your fingers when cleaning ignition plug.

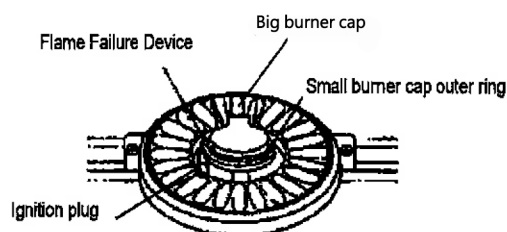

- Always keep the burner and the surroundings clean to prevent trouble of ignition.
- It is suggested to wear safety gloves while cleaning the appliance. Safety gloves could protect the hands from being hurt by metal blurs and sharp corners

# Trouble Shooting

Trouble	Cause and Remedy
Difficult to turn on. Easy to be extinguished.	The ignition knob is not pressed properly and adequately. → Turn it to its off position first. Then, press and turn it anti-clockwise slowly. Keep pressing it until the burner is ignited.
	Main gas valve closed → Open the valve.
	Air is trapped in the flexible tubing → Repeat the "Turn On" procedures until the burner is ignited.
	Flame failure sensors are dirty or wet → Remove and clean the moisture and dirt.
Uneven Flame Flame becomes yellowish and red Flame are extinguished during operation Abnormal sound is heard	No gas supplied → Replace it with the new one or inform gas supplier.
	Flame failure sensors are dirty or wet → Remove and clean the moisture and dirt.
	Slits in the burner cap are clogged → Clean the cap with brush or toothbrush or the like.
	Burner caps are not mounted properly → Make sure the cap is mounted in place.
	Humidifier is used in the room → The flames becomes yellowish by calcium in vaporized water. This is not trouble.

If safety check and maintenance service is required, contact your appliance dealer.



## Specifications

Type of Product	Single Burner Gas Cooker	
Model No.	RG-10S, RG-10SA	
Gas Type	HKLPG	
Gas Pressure(kPa)	2.90	
Rated Heat Input (kW)	4.50	
Ignition	Piezo Spark Ignition	
Safety Device	Flame Failure Device	
Dimensions (mm)	300(W)x157(H)x414(D) (Up to trivet level)	
Weight (kg)	2.90	
Gas Inlet	Ø8.8 Flexible Tubing	G 1/2 Stainless Steel tubing