

Rasonic
樂信牌

RTN-K12

多士焗爐
Toaster Oven



僅供家庭使用
For household use only

使用說明書

OPERATION MANUAL

- 在使用本產品前，請仔細閱讀本說明書。閱讀後小心收藏，以備日後查閱。
Please read the operation manual carefully before using. Keep it in a safe place for future reference.
- 本說明書中的圖示可能有與實物不同的地方，僅供參考。
The images in the operation manual may not match with the real object and are for reference only.

非常感謝您選購樂信牌多士焗爐，請在使用前詳細閱讀本說明書，並保存以備日後參考。

目錄



1. 安全注意事項
2. 產品規格
3. 產品說明
4. 首次使用
5. 使用方法
6. 清潔及儲存
7. 特別聲明
8. 售後服務

RTN-K12 | 多士焗爐 Toaster Oven



1. 安全注意事項

使用本產品時，必須遵守下列安全預防措施：

下圖表示由於錯誤操作而引起不同程度的危險等級。

	警告： 此標誌表示可能造成傷亡。
	注意： 此標誌表示可能造成傷害或財產損失。

以下不同標誌區分各種必須遵守的指示。

	此標誌表示禁止。
	此標誌表示必須遵守。

 注意			
	使用時或剛使用後，切勿接觸多士焗爐灼熱部分如外殼、玻璃爐門、烤盤、烤網或發熱管等，以免燙傷。接觸灼熱部分時，應使用隔熱手套，以免燙傷。		如多士焗爐發生冒煙或起火現象，請保持爐門緊閉，以免因遇上空氣而加大火勢。在安全的情況下，立即拔去電源插頭或關掉屋內電源總開關。切勿用水滅火，以免玻璃門爆裂。
	如長期不使用，發熱管可能會積聚油漬，再次使用時可能會產生大量油煙，此乃正常現象。		剛使用後，發熱管會有餘熱，請勿接觸，以免燙傷。
	請確保多士焗爐上方至少需要20厘米的散熱空間、四周及背面至少需要10厘米的散熱空間，切勿在櫥櫃或櫥架下方使用。		切勿使用任何物件蓋著多士焗爐表面或散熱位，特別是金屬物件、難於散熱或易燃物料，避免多士焗爐過熱而導致故障。
	切勿在電源線纏結的情況下使用或將電源線懸掛在桌子、櫥櫃的邊緣或讓它接觸發熱的表面，否則會損害電源線。		切勿將重物或剛從多士焗爐取出的灼熱容器擺放在打開的爐門玻璃上，以免造成玻璃爆裂及危險。
	打開爐門玻璃時，請輕放，防止爐門玻璃或門柄損壞。		使用中或剛使用後，切勿用冰水或冷水清洗爐門玻璃，避免造成破裂。
	不可在電源線上放重物、夾住、改裝、用力拉扯或扭曲電源線。		在插入或拔除插頭時，應手握穩插頭本身，不要抓住電源線。
	使用前，確保碎屑盤已關妥，以免燒焦檯面及引起火災。		使用後，請拔出插頭及待冷卻後才移動、清潔或檢查多士焗爐。

 警告

	為免危險，請按照此說明書建議方法使用，切勿在室外使用或用作烤焗食物以外的其他用途。如錯誤操作，可造成傷害。		切勿烤焗塗有牛油或果醬的麵包或在烤盤上塗油，避免產生油煙或引起火災。
	切勿與其他高功率的電器共用同一電源插座；或超額使用電線拖板，以免電力負荷過重而導致火災。		此多士焗爐只可供家庭或類似環境使用，如商戶內部、辦事處和其他工作環境的員工廚房區域；旅館、汽車旅館和其他住宿類型的環境。
	切勿將易燃物料(如紙類或卡片等)或密封容器(如塑膠、罐類或玻璃瓶等)放入多士焗爐中進行烤焗。		請確保多士焗爐連接於帶接地綫插座。為避免危險，請勿在多士焗爐加裝定時開關或獨立的遙控系統來操作。
	切勿讓多士焗爐在無人看管下運作。		手濕時切勿接觸、插入或拔除插頭，否則可構成觸電的危險。
	切勿使用有殘缺或鬆動的插座。使用前，確保插頭已充分擦乾及已插緊。		切勿把多士焗爐、電源線或插頭浸入水中；或被水濺濕，以免造成觸電或火災。
	切勿讓小孩單獨使用、清潔及維修保養多士焗爐或把其當作玩具。請將多士焗爐及其電源線放於小孩不能接觸的地方。		此多士焗爐可供年齡在8歲或以上的兒童及體質、感覺或智力有障礙人士或缺乏經驗和相關知識的人士使用，但他們必須接受負責安全人士的監督或指導如何安全地使用多士焗爐和理解所涉及的危險。
	切勿擅自改裝多士焗爐或使用非生產商提供的原裝零件進行修理，否則可能造成危險及維修保養將無效。		使用後，應將插頭從插座內拔出，以免因絕緣老化而發生漏電。
	經常檢查多士焗爐、電源線及插頭，如有損壞，為避免危險，應立即停止使用，並聯絡信興電器服務中心有限公司安排檢查及維修。		切勿在以下環境使用多士焗爐： 一 潮濕或接近水的環境 一 被陽光直接照射或靠近熱源如煮食爐及火源 一 在不平穩的表面上 一 易燃物料或不耐熱物品附近(如枱布、窗簾及毛巾等)

2. 產品規格

型號	RTN - K12/*
*顏色	P = 粉紅色 / B = 淺藍色
額定電壓	220-240伏特~ 50赫茲
額定功率	1,000瓦
溫度控制	最高為240°C (±30°C為正常範圍)
淨重	2.7公斤
烤盤尺寸(闊 x 深 x 高)	250 x 210 x 15毫米
產品尺寸(闊 x 深 x 高)	310 x 290 x 215毫米

3. 產品說明

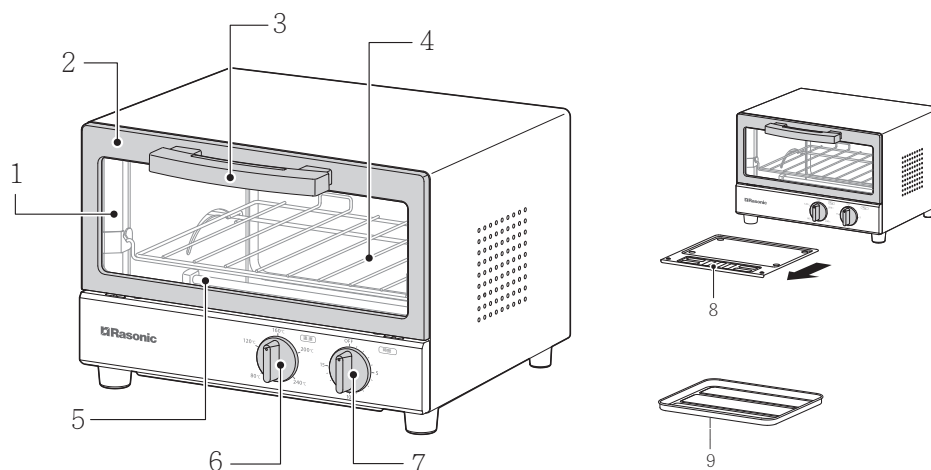

(以上產品圖片僅供參考，請以實物為準。)

1. 爐門玻璃
2. 爐門
3. 門柄
4. 烤網
5. 發熱管
6. 溫度旋鈕
7. 時間旋鈕
8. 碎屑盤
9. 烤盤

※烤盤中間凸起，此形狀並非不正常。此設計適合多士焗爐的運作。加熱後，烤盤可能會彎曲，屬正常現象。

4. 首次使用

首次使用前，請按以下步驟進行空燒以清除新機氣味：

1. 拆除烤網固定帶，並取出所有配件，用清水洗淨及擦乾。
2. 連接電源前，請檢查時間旋鈕在“OFF”的位置。
3. 將溫度旋鈕設定在240°C，時間旋鈕設定為5分鐘。空燒時可能會冒煙及氣味，此屬正常現象。
4. 空燒後，必須待多士焗爐冷卻才可再次使用。

5. 使用方法

1. 請確保時間旋鈕在OFF(關)的位置，並把電源插頭插入插座。
2. 將食物平均地放置在烤網或烤盤上，再放入爐內。如烹調會釋出油脂或有醬汁的食物時，請先用錫紙包裹食物再放烤盤上。如使用烤網，請確保食物不會從烤網跌出。如食物比較細小，可放在烤盤上烤焗。請放好食物後才關上爐門。
3. 將溫度旋鈕設定到所需溫度。
※ 發熱管會間斷地亮起以調整溫度，此乃正常現象。
4. 將時間旋鈕設定到所需烹調時間，多士焗爐啟動。
※ 如設定5分鐘或以下的烤焗時間，請扭動時間旋鈕至6分鐘或以上，再回轉至所需時間。
5. 烹調完成後，時間旋鈕會轉回“OFF”的位置，多士焗爐會發出鳴聲提示。
※ 如需在烹調過程中停止烤焗，可手動將時間旋鈕回轉至“OFF”的位置。
※ 時間旋鈕轉回“OFF”的位置，仍有可能發出滴答聲，屬正常現象。
6. 使用後，請把電源插頭從插座拔出。

烹調注意事項：

1. 經冷凍的食物需要較長的烤焗時間，請根據實際烹調情況調整烤焗時間。
2. 烹調時間因食物的溫度、種類、份量等不同而各有差異，請根據實際情況進行調整。
3. 時常留意烤焗中的食物，避免烤焦。烤焗容易燒焦的食物，請用錫紙蓋住。
4. 烘烤時，水蒸氣可能會凝聚於爐門周邊或玻璃上。這是由於食物當中的水分蒸發所造成，此為正常現象。
5. 使用時，多士焗爐可能有聲音發出，這是由於加熱時物料和食物膨脹，並不表示發生故障。
6. 烤焗會釋出油脂或有醬汁的食物時(如生肉、魚、炸物等)，請用錫紙包裹食物及放於烤盤上，避免因食物油脂或醬汁濺到發熱管而起火。
7. 請確保錫紙或牛油紙沒有接觸到發熱管，以免發生火災。另外應注意錫紙及牛油紙可能會因烹調時間和狀況而導致起火。
8. 在連續烹調食物的間隔期間，請保持爐門打開，讓多士焗爐在烹調下一個食物之前冷卻下來。

6. 清潔及儲存

1. 清潔前，必須先拔出電源插頭。
2. 每次使用後，必須在多士焗爐處於微溫時清潔內腔，並須清潔烤網及烤盤，避免油脂或食物渣滓積聚導致使用時產生油煙、引起火災或造成侵蝕生鏽。使用前，必須擦乾多士焗爐、插頭及所有配件。
3. 清潔烤盤、烤網及碎屑盤時，可用軟抹布或海綿沾上中性清潔劑清洗，再用清水沖洗後擦乾。

4. 清潔多士焗爐外殼及內腔時，可用濕軟抹布清潔再擦乾。
5. 切勿使用粗糙的潔具(如鋼絲刷)、有毒或含腐蝕性的清潔劑進行清潔。
6. 多士焗爐底部有活動碎屑盤，可拉出進行清潔。清潔後，必須裝回原位才可使用。
7. 儲存時，請將多士焗爐放入紙箱及放置在乾爽的環境中。
8. 儲存時，切勿將電源線纏繞在多士焗爐四周或壓住電源線，避免造成電源線損壞。

7. 特別聲明

1. 此說明書所有內容經過核對，如有任何印刷錯誤或內容上的誤解，本公司將保留解釋權。
2. 本產品若有技術改進，會編進新版說明書中，恕不另行通知；產品外觀及規格以廠方生產資料為準。

8. 售後服務

信興電工工程有限公司(“本公司”)將授權信興電器服務中心有限公司(“服務中心”(統稱“信興”)提供一年保修服務(並由發票上的日期起計)。超過這期間者，客戶須按服務中心的修理服務價目表繳付一切費用。

1. 信興對於任何因產品不適當地使用或任何產品之故障、損壞或停頓而引致任何人士或財產的直接或間接損失及破壞，概不負責。
2. 客戶須自行將產品送往客戶服務中心或市區內，並於產品修妥後於同一地點取回。
3. 保修卡(印在包裝盒上)只適用於香港及澳門。於修理時，客戶需出示保修卡及由香港或澳門經銷商發出的正式發票 / 換購收據予技術員查閱。保修卡上之產品型號必須與機身相符，保修卡上之購買日期須與正式發票上的日期符合，方為有效。除指定保修卡外，任何商號及人士發出之保修卡，均不為信興認可。
4. 客戶不可擅自更改產品上的機身編號，如發現產品上的機身編號與保修卡所列者不符，保修卡則告無效。(如適用)
5. 除產品表面、機殼、損耗性零件及附件外，產品如在保修期內發生故障，經服務中心證實乃在正常使用情況下發生者，服務中心將提供免費修理及更換零件，經更換後之任何損壞零件，將歸服務中心所有。
6. 下列項目並不包括於保修範圍內。客戶須另付所需的服務費用。(甲)修理或更換產品之附件、外接線及機殼。(乙)曾被非服務中心的技術員明顯地或不明顯地進行改裝、更改或修理的產品。(丙)曾經被不適當或疏忽使用、不正常供電或電壓不正常、意外、天災或因昆蟲、外物、液體入侵、腐蝕或外來因素而造成損壞的產品。(丁)因產品不正確安裝而影響正常之操作。
7. 如中英文版本有差異時，應以中文版為準。
8. 所有資料如有任何更改，恕不另行通知。如有任何爭議，服務中心保留最終決定權。
9. 保修卡沒有賦予或意圖賦予任何第三者因《合約(第三者權利)條例》(第623章)所列之任何利益或權利以強制執行保修卡的任何條款內容。

Thank you for choosing Rasonic Toaster Oven. Please read the operation manual carefully before use and keep it for your future reference.

Table of Contents



1. Important Safeguards
2. Product Specifications
3. Product Descriptions
4. First Use
5. Operation Instructions
6. Cleaning and Storage
7. Special Avowal
8. After Sales Service

RTN-K12 | 多士焗爐 Toaster Oven



1. Important Safeguards















When using the appliance, please follow the below basic safety precautions:

The following chart indicates the degree of damage caused by wrong operation.

















	Warning: Indicates that may cause death or severe injury.
	Caution: Indicates hazards that may cause human injuries or property damages.

The following symbols can distinguish the instruction types that need to be strictly followed.

	These symbols mean prohibition.
	These symbols mean requirement that must be followed.

 Caution			
	When the appliance is in use or just after use, do not touch the hot parts such as the housing, glass door, bake tray, grill rack or heat elements etc, to avoid burns. When touch the hot part, always wear the oven gloves to avoid getting burns.		If the appliance smoke or catch fire, please keep the oven door closed as air will trigger the fire to burn more vigorously. You should unplug it from the power socket at once or turn off the master switch under a safe situation. Never try to put out the fire with water to avoid the oven glass door crack.
	If the appliance is not in use for a period, grease may accumulate on the heat element. Excessive smoke may occur when it is used again which is normal.		There is residual heat on the heat elements after use. Do not touch to avoid burns.
	Make sure there is at least 20 cm clearance above the appliance and 10 cm clearance on its surrounding and back for ventilation. Do not operate the appliance under a wall cupboard or shelf.		Do not cover the appliance surface or air vents with any objects especially metal objects, heat-insulated or inflammable materials. It is to avoid unit malfunction due to overheat.
	Do not operate the appliance when the power cord is tangle or hang the power cord over the edge of a table, counter-top or let it touch any hot surface, it may damage the power cord.		To avoid glass crack and danger, never put any objects or heated containers just taken out from the oven on the open glass door.
	Be cautions when opening the door glass, to prevent damage to the door glass or door handle.		When the appliance is in use or right after use, do not clean the door glass with ice or cold water. Otherwise, the door glass may be broken.
	Do not place heavy objects on the power cord. Never clip, modify, stretch or twist the power cord.		Grasp the plug itself when plug in or unplug the appliance, do not grasp the power cord.
	When in use, please make sure the crumb tray is installed to avoid table burns and fire.		After use, please unplug the appliance and let the appliance cool down before moving, cleaning or checking.

Warning

	To avoid danger, please use the appliance according to the operation manual. Do not use it outdoors or other purpose except baking food. Misuse can cause potential injury.		Do not toast bread with butter or jam or spread oil on the bake tray to avoid smoke or fire.
	Do not use the same socket with other high wattage appliance or use the extension cord beyond its capacity to avoid overload and danger.		The appliance is intended to be used in household or similar applications such as staff kitchen in shops, offices and other working environments; by clients in hotels, motels and other residential type environments.
	Never put inflammable materials (e.g. paper or cardboard, etc.) or sealed containers (e.g. plastic, cans or glass bottles, etc.) into the appliance for cooking.		Please make sure the appliance is connected to power socket with earth wire. To avoid hazards, never connect the appliance to a timer switch or separate remote control system.
	Never leave the appliance unattended when in use.		Do not touch, plug in or remove the plug with wet hands, it can cause electric shock.
	Do not use deficient or loosen socket. Before use, make sure the plug is dry and inserted firmly.		Never immerse the main body, power cord or plug in water or let them wet, it can cause electric shock.
	Never allow children to operate, clean or perform user maintenance on the appliance alone or play as toy. Please put the appliance and its power cord in a place not reachable by children.		The appliance can be used by children aged from 8 years and above and persons with reduced physical, sensory or mental capabilities, or lack of experience and knowledge, if they have been given supervision or instruction concerning use of the appliance in a safe way and understand the hazards involved.
	Do not attempt to modify the appliance by yourself or repair with any unauthorized parts, otherwise it will cause hazards and the warranty will become invalid.		Always unplug the appliance from the power socket after use to avoid electric leakage due to insulation parts degeneration.
	Always check the condition of the appliance, power cord and plug. To avoid hazards, if the power cord is damaged, stop using the appliance immediately and contact Shun Hing Electric Service Centre Ltd. for checking and repairing.		Do not operate the appliance in following places: <ul style="list-style-type: none"> - Humid environment or near water - Expose to sunlight or near heat sources such as cooker and fire - Unstable surface - Near inflammable or non-resistant to heat objects (e.g. table cloth, curtain and towel etc.)

2. Product Specifications

Model	RTN - K12/*
*Colour	P = Pink / B = Baby Blue
Rated Voltage	220-240V~ 50Hz
Rated Power	1,000W
Temperature Control	Max. 240°C (±30°C is the normal range)
Net Weight	2.7kg
Bake Tray Size (W x D x H)	250 x 210 x 15 mm
Product Size (W x D x H)	310 x 290 x 215 mm

3. Product Descriptions

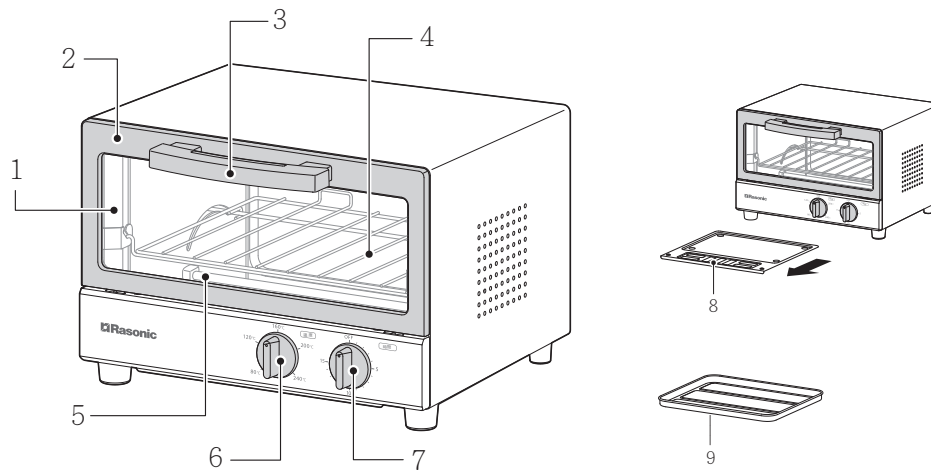

(Above product drawing is for reference only, appearance please refer to actual product.)

1. Door glass
2. Door
3. Door handle
4. Grill rack
5. Heat elements
6. Temperature knob
7. Timer knob
8. Crumb tray
9. Bake tray

※ The bake tray curves up in the middle. This shape is not an abnormality. It has been designed this way to suit the toaster oven's function. It is normal that the bake tray may bend when it is heated.

4. First Use

Before first use, operate the oven empty to eliminate the smell of new oven by the below procedures:

1. Remove the binding ties that secure the grill rack, take out all the accessories, rinse with clean water and dry up.
2. Before connecting to the power source, please check the timer knob is at "OFF" position.
3. Set the temperature knob at 240°C, the timer knob at 5 minutes. When operate the appliance empty, smoke and smell may appear which is normal.
4. After operate the oven empty, must allow it to cool down before use.

5. Operation Instructions

1. Make sure the temperature knob is at OFF position. Plug in the oven to the power socket.
2. Put the food on the grill rack or bake tray evenly, then put into the oven. If cooking food which is greasy or rich in sauce, please wrap the food with aluminum foil and then put on the bake tray. When use the grill rack, please make sure the foods do not leak through the rack, or you may use bake tray for food in small species. Close the oven door after settling the food.
3. Select the temperature by rotating the temperature knob.
※ It is normal that the heating element will be off temporarily when the appliance reaches the preset temperature and on again when the temperature declines to adjust the temperature.
4. Select the cooking time by rotating the timer knob and the oven will turn on.
※ If the cooking time is 5 minutes or shorter, please turn the timer knob over 6 minutes and rotate back to the required time.
5. When the cooking time is finished, the timer knob will back to "OFF" position, it will have a signal sound.
※ If you want to switch off the oven during cooking, you can turn the timer knob to "OFF" manually.
※ You may hear the timer continue to tick even the timer knob is back to "OFF" position. This is not a malfunction.
6. After use, please unplug the oven from the power socket.

Cooking Precautions:

1. Frozen food may take longer time to cook, please adjust the cooking time according to the actual cooking condition.
2. The cooking time is varied with different food temperature, types, quantity etc. Please adjust it according to the actual cooking condition.
3. Always pay attention to the food during cooking to avoid overcook. Use aluminum foil to cover the food which easily overcook when cooking.
4. When cooking, water vapor may condense around oven door or on the door glass. This is because water evaporates from the food which is normal.
5. There may be sounds when the oven is operating, it is due to heat expansion of material and food, and it does not indicate any malfunction.
6. When cooking foods which are greasy or marinated with sauce (e.g. raw meat, fish, deep-fried food, etc.), please wrap the food with aluminum foil and put them on the bake tray. It is to avoid the food grease or sauces from spilling onto the heat elements and cause fire.
7. Make sure the aluminum foil or cooking sheet does not touch the heat elements to avoid fire. Also, please note that the aluminum foil and cooking sheet could start a fire depending on the cooking time and conditions.
8. When cooking items one after another, leave the door open so that the oven can cool down before cooking the next item.

6. Cleaning and Storage

1. Must unplug the appliance before cleaning.
2. After each use, must clean the toaster oven cavity when it is lukewarm. And also clean the grill rack and bake tray to avoid smoke, fire or metal erosion caused by the accumulated grease or food residue. Always make sure the oven, power plug and all accessories are dried before use.
3. When clean the grill rack, bake tray and crumb tray, please use a soft cloth or sponge soaked with mild detergent, then wash with clean water and wipe them dry.

4. Clean the oven surface and cavity by a damp cloth, then rub it dry.
5. Never clean with harsh cleaning tools (e.g. metal-wired brush), or use poisonous or corrosive detergent to clean.
6. A removable crumb tray is at the bottom of the oven that can be pulled out for cleaning. Make sure it must be put back in place before use.
7. When store, put the oven in a box and store in a dry place.
8. When store, never wrap the power cord around the oven or put any pressure on the power cord, it is to avoid the power cord damage.

7. Special Avowal

1. The content in the operation manual has been checked. Our company reserves the hermeneutic power to any printing errors or misunderstanding on the content.
2. If there are technical improvements on the appliance, the operation manual will be updated in new version without prior notice. The product appearance and specification are subject to the manufacturer information.

8. After Sales Service

Shun Hing Electric Works & Engineering Co., Ltd. ("The Company") authorizes Shun Hing Electric Service Centre Ltd. ("SHESC") (collectively "Shun Hing") to offer one year warranty service to the product commencing from the date of purchase invoice. Services beyond the said warranty period will be charges according to the standard service charge price list from SHESC.

1. Shun Hing shall not be liable for any direct or indirect loss or damage to any person or property, howsoever caused arising from improper use, or any stoppage, breakdown or failure of the product.
2. Customer is responsible to deliver the product to our service station or any place in urban area, and to pick up the repaired product from the same location.
3. The warranty card (printed on the packing box) is valid only in Hong Kong and Macau. Customer is required to present the warranty card together with the official purchase invoice issued by the dealers of Hong Kong or Macau or redemption voucher to our technician for verification when service is rendered. The warranty card is valid only if the model number stated herein corresponds with that of the product and the date of purchase stated herein is the same with the date of official purchase invoice. Save and except the specific warranty card, any other warranty card issued by other parties will not be recognized by Shun Hing.
4. Customer shall not alter the serial number of the product. The warranty card is void if the serial number on the product does not match with that shown on the warranty card (if applicable).
5. For any defect which in our judgment is caused under normal use, SHESC will repair or replace the defective parts, excluding any surface, cabinet, consumptive parts and accessories, free of charge within the warranty period. Any defective part which has been replaced shall become the property of SHESC.
6. Warranty service does not cover the following items. Additional charges shall be levied if services are required. (a) Repair or replacement of accessories, external cables or cabinet of the product. (b) The product has been explicitly or implicitly modified, tempered with, altered or repaired in any way by persons other than technicians of SHESC. (c) The product has been damaged through misuse, negligence, power interruption or abnormal voltage input, accident, natural calamities, or due to ingress of insects, foreign matters or liquid, corrosion or external factors. (d) The normal operation of the product is affected by improper installation of the product.
7. In case there is any inconsistency or conflict between English version and Chinese version of the terms, the Chinese version shall prevail.
8. All terms stated are subject to change without notice. SHESC retains final deciding authority in case of dispute.
9. Nothing in the warranty card confers or purports to confer on any third party any benefit or any right pursuant to the Contracts (Rights of Third Parties) Ordinance (Cap. 623) to enforce any term of the warranty card.



Rasonic 樂信牌

信興電工工程有限公司

SHUN HING ELECTRIC WORKS AND ENGINEERING CO., LTD.

辦公室：香港九龍尖沙咀東部麼地道67號半島中心9樓909-912室

電話：2861 2767

圖文傳真：2865 6706

網址：<http://www.rasonic.com>

電郵：shew@shunhinggroup.com

Office: Room 909-912 9/F., Peninsula Centre, 67 Mody Road, Tsimshatsui East, Kowloon, H.K.

Tel: 2861 2767

Fax: 2865 6706

Website: <http://www.rasonic.com>

E-mail: shew@shunhinggroup.com

保養及維修 Maintenance and Repair Service:

信興電器服務中心有限公司

SHUN HING ELECTRIC SERVICE CENTRE LTD.

香港新界葵涌勝耀街8號信興中心18樓

電話：2406 5666

圖文傳真：2408 0316

網址：<http://www.shunhing-service.com>

18/F, Shun Hing Centre, 8 Shing Yiu Street, Kwai Chung, N.T., H.K.

Tel: 2406 5666

Fax: 2408 0316

Website: <http://www.shunhing-service.com>

消耗品/附件銷售熱線：2406 5555

Consumables/Accessories Sales Hotline: 2406 5555

客戶服務中心：

香港新界葵涌勝耀街8號信興中心19樓

電話：(852) 2406 5439

傳真：(852) 2408 1389

澳門慕拉士大馬路193-199號南嶺工業大廈5樓1座

電話：(853) 2836 2928

傳真：(853) 2833 6405

有關最新客戶服務中心資訊，請參閱信興服務中心網址：www.shunhing-service.com或致電維修服務熱線查詢。

Customer Service Centres:

19/F, Shun Hing Centre, 8 Shing Yiu Street, Kwai Chung, N.T.

Tel: (852) 2406 5439

Fax: (852) 2408 1389

Avenida de Venceslau de Morais, No. 193-199, 5 andar-l, Edf.

Tel: (853) 2836 2928

Fax: (853) 2833 6405

Industrial Nam Leng, Macau

For the latest information of customer service centres, please visit www.shunhing-service.com or call us at our hotline.